

- Laptop-Schublade CAVO 350mm
- Laptop drawer CAVO 350mm
- Tiroir pour ordinateur portable CAVO 350mm

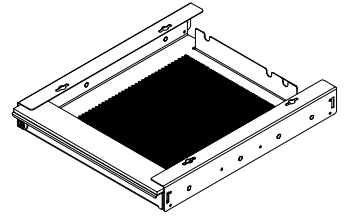

- 1**
- Einbaumaße.
 - Installation dimensions.
 - Dimensions d'installation.

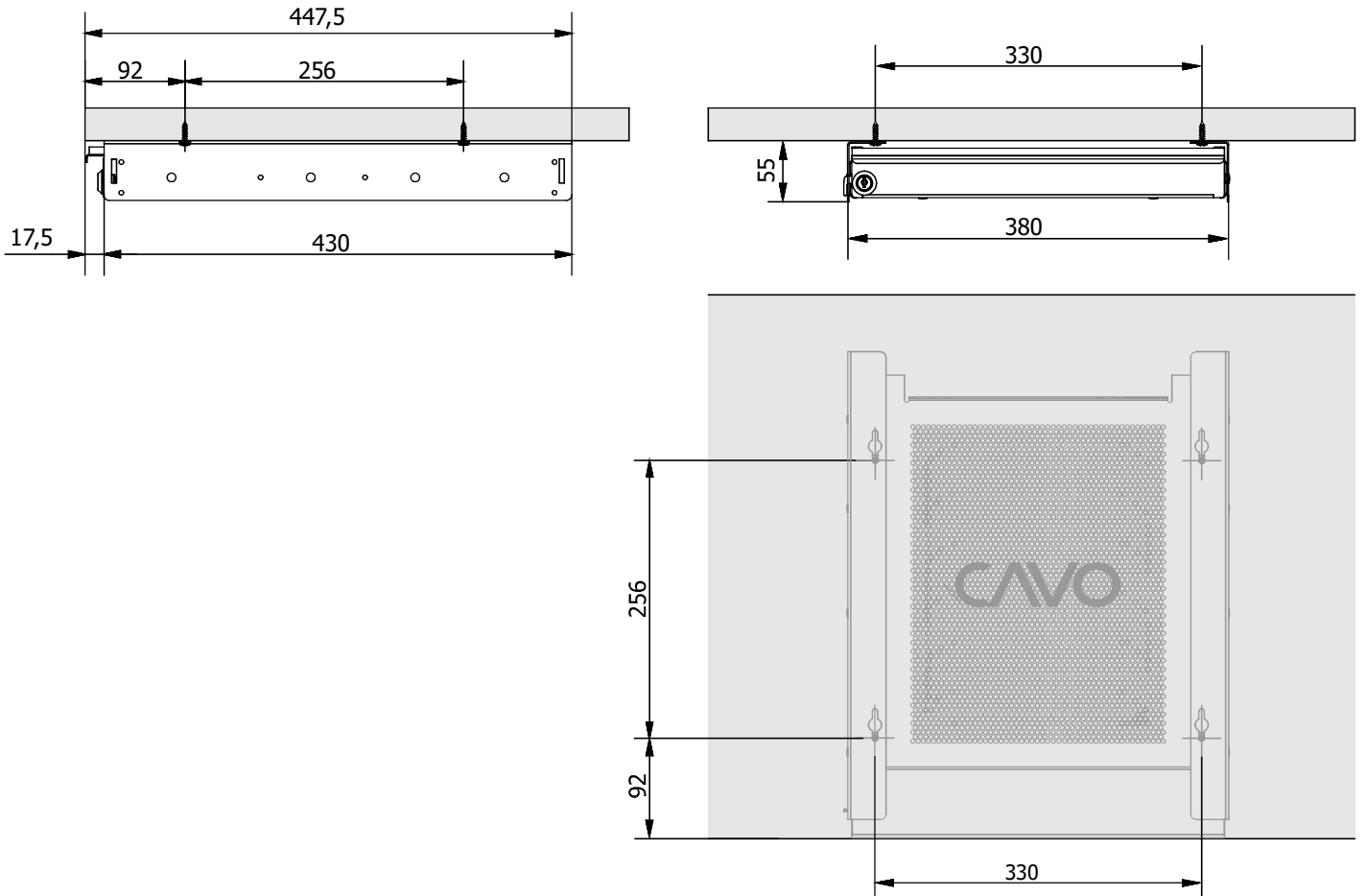

- 2**
- Löcher gemäß den Einbaumaßen vorbohren.
 - Drill holes at designated points.
 - Pré-percer les trous selon les dimensions de montage.

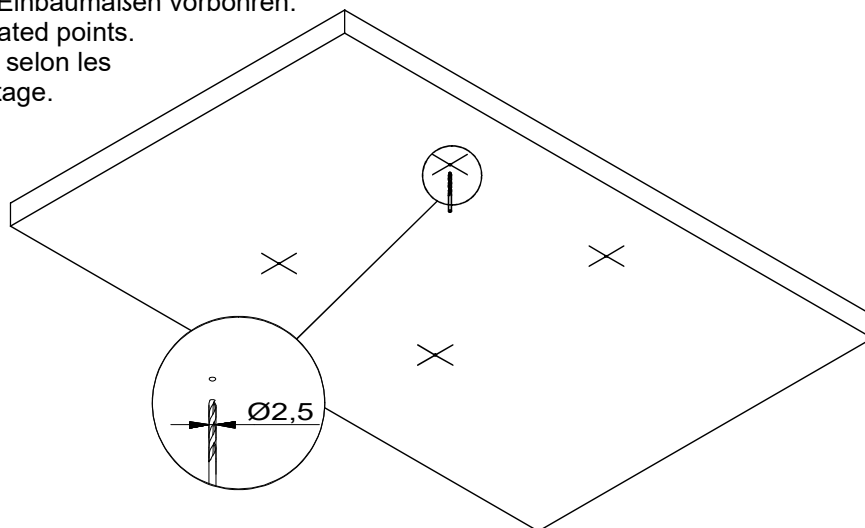

- 3** - Schrauben einschrauben und ca. 3mm herausstehen lassen.
 - Screw the screws into the holes leaving a distance of approx. 3 mm.
 - Visser les vis et les laisser dépasser d'environ 3 mm.

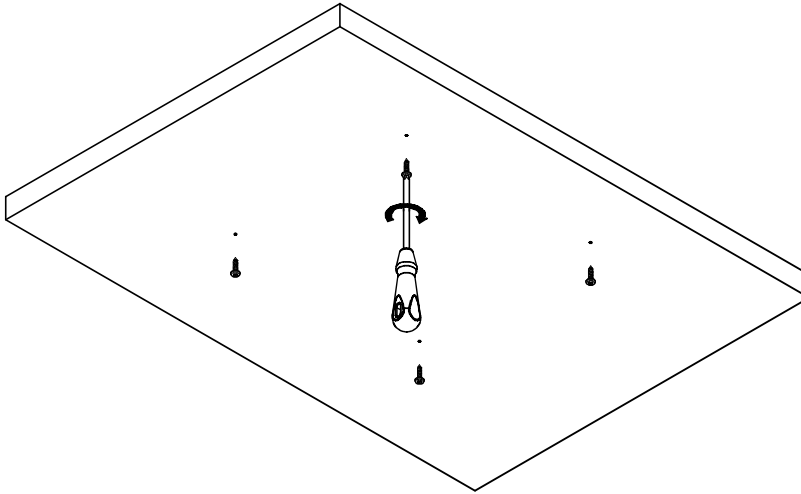

- 4** - Die Schienen in die Montagelöcher einführen und nach hinten schieben.
 - Place the sides of the slides on the screw heads and slide backwards.
 - Insérer les coulisses dans les trous de montage et les pousser vers l'arrière.

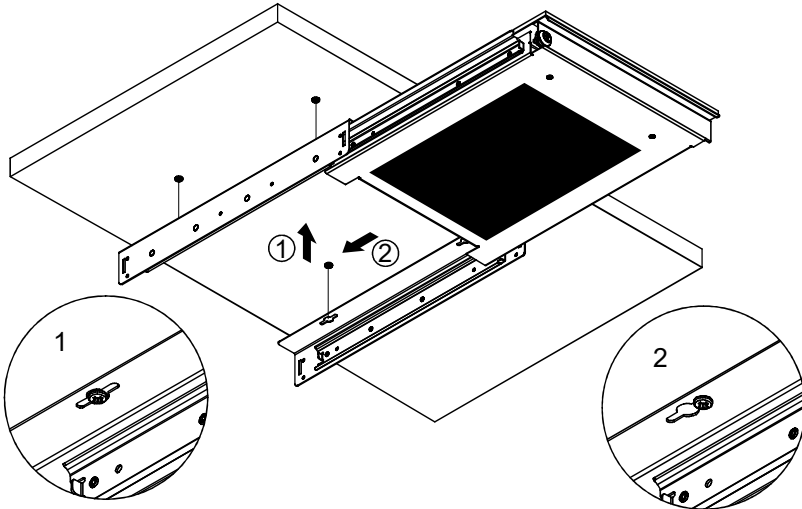

- 5** - Alle Schrauben festziehen.
 - Tighten all screws.
 - Serrer toutes les vis.

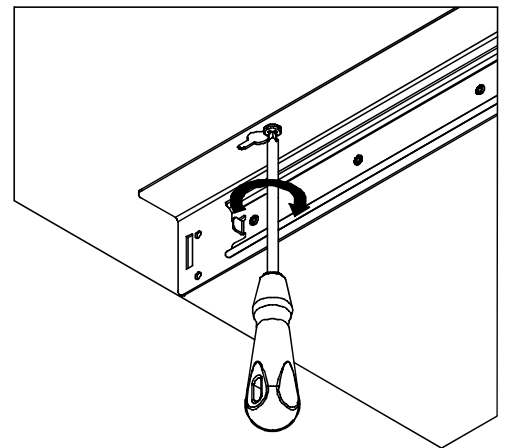

- 6** - Schubkasten einschieben.
 - Insert the drawer.
 - Insérer le tiroir.

